

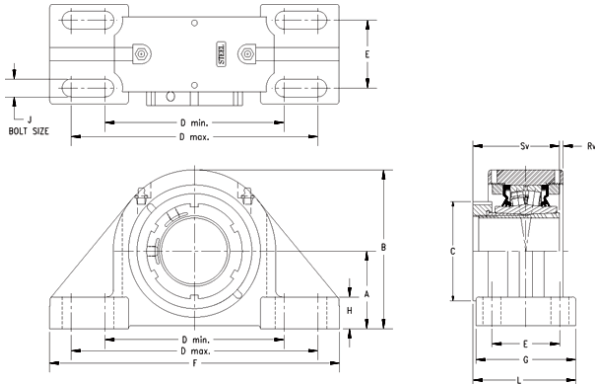

TON BEARING CO.,LTD.



timken QVPK26V408S Solid Block/Spherical Roller Bearing Housed Units-Single V-Lock Four-Bolt Pillow Block

Bearing No. QVPK26V408S

QVPK26V408S Bearing 2D drawings and 3D CAD models

Engineering Group	Mounted Bearing
Shaft Size	4-1/2 in
Shaft Size Type	Imperial
Full Timken Part Number	QVPK26V408SB
Locking Style	Single V-Lock
Weight	136 lb
Housing Style	Four-Bolt Pillow Block
UPC Code	0883450056663
Dimension A	6.13 in
Dimension B	11.15 in
Dimension C	6.88 in
Dimension D Max	16.75 in
Dimension D Min	15.25 in
Dimension E	4.25 in
Dimension F	20.25 in
Dimension G	6.7500 in
Dimension H	2.00 in
Dimension L	6.90 in
Dimension RV	0.04 in
Dimension SV	5.82 in
C0 - Static Load	212000 lb
C - Dynamic Load (Basic)	170000 lb
e - Geometry Factor	0.26
Y1 - Geometry Factor	2.62
Y2 - Geometry Factor	3.90



TON BEARING CO.,LTD.

Oil Lubrication - M/N Seal	700 rpm
Oil Lubrication - T Seal	1500 rpm
Oil Lubrication - B/C/O Seal	400 rpm
Grease Lubrication - M/N Seal	700 rpm
Grease Lubrication - T Seal	1000 rpm
Grease Lubrication - B/C/O Seal	400 rpm
Float	0.083 in
Shaft Tolerance	0.0050 in
Eng Internal Radial Clearance - Min	0.0053
Eng Internal Radial Clearance - Max	0.0067
Pre Install Clearance Min	0.0053 in
Pre Install Clearance Max	0.0067 in