

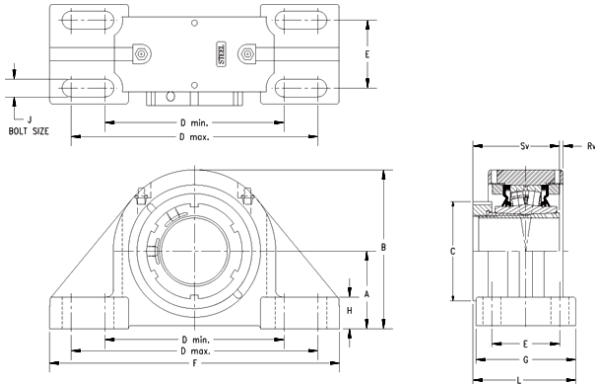

TON BEARING CO.,LTD.



timken QVPK22V312S Solid Block/Spherical Roller Bearing Housed Units-Single V-Lock Four-Bolt Pillow Block

Bearing No. QVPK22V312S

QVPK22V312S Bearing 2D drawings and 3D CAD models

Engineering Group	Mounted Bearing
Shaft Size	3-3/4 in
Shaft Size Type	Imperial
Full Timken Part Number	QVPK22V312SB
Locking Style	Single V-Lock
Weight	87 lb
Housing Style	Four-Bolt Pillow Block
UPC Code	0883450149327
Dimension A	5.75 in
Dimension B	10.78 in
Dimension C	5.5 in
Dimension D Max	15.56 in
Dimension D Min	13.94 in
Dimension E	4.00 in
Dimension F	18.500 in
Dimension G	6.2500 in
Dimension H	1.80 in
Dimension L	5.45 in
Dimension RV	0.19 in
Dimension SV	4.13 in
C0 - Static Load	147000 lb
C - Dynamic Load (Basic)	125000 lb
e - Geometry Factor	0.25
Y1 - Geometry Factor	2.73
Y2 - Geometry Factor	4.06



TON BEARING CO.,LTD.

Oil Lubrication - M/N Seal	900 rpm
Oil Lubrication - T Seal	1700 rpm
Oil Lubrication - B/C/O Seal	600 rpm
Grease Lubrication - M/N Seal	900 rpm
Grease Lubrication - T Seal	1200 rpm
Grease Lubrication - B/C/O Seal	600 rpm
Float	0.083 in
Shaft Tolerance	0.0030 in
Eng Internal Radial Clearance - Min	0.0053
Eng Internal Radial Clearance - Max	0.0067
Pre Install Clearance Min	0.0053 in
Pre Install Clearance Max	0.0067 in