

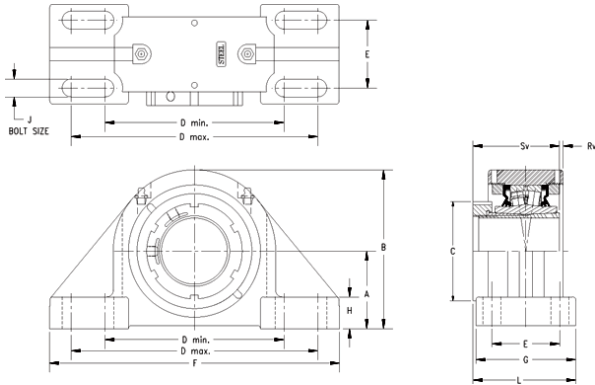

TON BEARING CO.,LTD.



timken QVPK20V307S Solid Block/Spherical Roller Bearing Housed Units-Single V-Lock Four-Bolt Pillow Block

Bearing No. QVPK20V307S

QVPK20V307S Bearing 2D drawings and 3D CAD models

Engineering Group	Mounted Bearing
Shaft Size	3-7/16 in
Shaft Size Type	Imperial
Full Timken Part Number	QVPK20V307SB
Locking Style	Single V-Lock
Weight	70.0 lb
Housing Style	Four-Bolt Pillow Block
UPC Code	0883450054669
Dimension A	5.00 in
Dimension B	9.44 in
Dimension C	4.9 in
Dimension D Max	14.00 in
Dimension D Min	12.50 in
Dimension E	3.50 in
Dimension F	16.75 in
Dimension G	5.5000 in
Dimension H	1.63 in
Dimension L	5.07 in
Dimension RV	0.55 in
Dimension SV	3.75 in
C0 - Static Load	113000 lb
C - Dynamic Load (Basic)	97700 lb
e - Geometry Factor	0.24
Y1 - Geometry Factor	2.85
Y2 - Geometry Factor	4.24



TON BEARING CO.,LTD.

Oil Lubrication - M/N Seal	1200 rpm
Oil Lubrication - T Seal	2000 rpm
Oil Lubrication - B/C/O Seal	900 rpm
Grease Lubrication - M/N Seal	1200 rpm
Grease Lubrication - T Seal	1600 rpm
Grease Lubrication - B/C/O Seal	900 rpm
Float	0.083 in
Shaft Tolerance	0.0030 in
Eng Internal Radial Clearance - Min	0.0043
Eng Internal Radial Clearance - Max	0.0055
Pre Install Clearance Min	0.0043 in
Pre Install Clearance Max	0.0055 in