

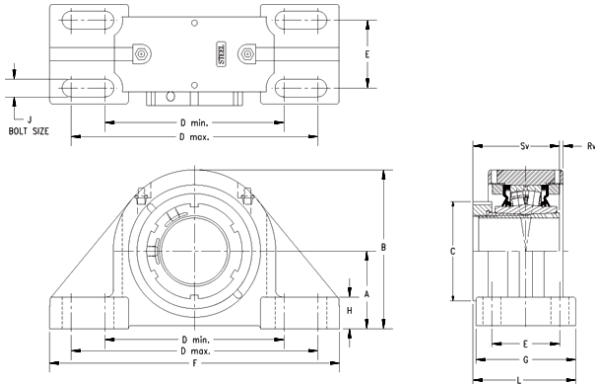

TON BEARING CO.,LTD.



timken QVPK15V208S Solid Block/Spherical Roller Bearing Housed Units-Single V-Lock Four-Bolt Pillow Block

Bearing No. QVPK15V208S

QVPK15V208S Bearing 2D drawings and 3D CAD models

Engineering Group	Mounted Bearing
Shaft Size	2-1/2 in
Shaft Size Type	Imperial
Full Timken Part Number	QVPK15V208SB
Locking Style	Single V-Lock
Weight	29 lb
Housing Style	Four-Bolt Pillow Block
UPC Code	0883450054256
Dimension A	3.50 in
Dimension B	6.83 in
Dimension C	3.7 in
Dimension D Max	10.44 in
Dimension D Min	9.06 in
Dimension E	2.75 in
Dimension F	13.000 in
Dimension G	4.2500 in
Dimension H	1.54 in
Dimension L	4.17 in
Dimension RV	0.11 in
Dimension SV	3.25 in
C0 - Static Load	54100 lb
C - Dynamic Load (Basic)	49900 lb
e - Geometry Factor	0.22
Y1 - Geometry Factor	3.14
Y2 - Geometry Factor	4.67



TON BEARING CO.,LTD.

Oil Lubrication - M/N Seal	1600 rpm
Oil Lubrication - T Seal	2900 rpm
Oil Lubrication - B/C/O Seal	1300 rpm
Grease Lubrication - M/N Seal	1600 rpm
Grease Lubrication - T Seal	2400 rpm
Grease Lubrication - B/C/O Seal	1300 rpm
Float	0.083 in
Shaft Tolerance	0.0015 in
Eng Internal Radial Clearance - Min	0.0030
Eng Internal Radial Clearance - Max	0.0037
Pre Install Clearance Min	0.0030 in
Pre Install Clearance Max	0.0037 in