

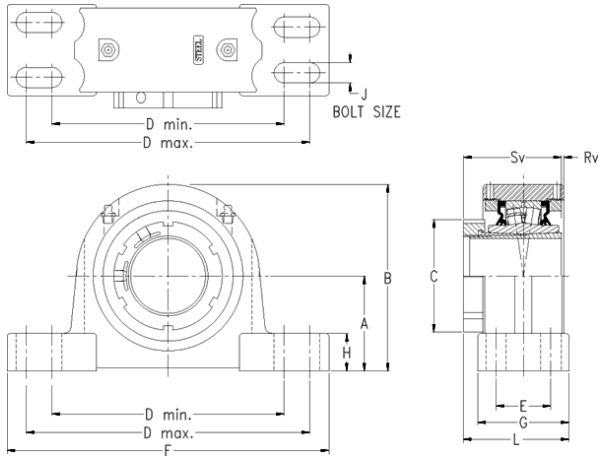

TON BEARING CO.,LTD.



timken QVPG11V115S Solid Block/Spherical Roller Bearing Housed Units-Single V-Lock Four-Bolt Pillow Block

Bearing No. QVPG11V115S

Engineering Group	Mounted Bearing
Shaft Size	1-15/16 in
Shaft Size Type	Imperial
Full Timken Part Number	QVPG11V115SB
Locking Style	Single V-Lock
Weight	19 lb
Housing Style	Four-Bolt Pillow Block
UPC Code	0883450147118
Dimension A	2.75 in
Dimension B	5.31 in
Dimension C	2.99 in
Dimension D Max	8.56 in
Dimension D Min	7.18 in
Dimension E	1.57 in
Dimension F	9.88 in
Dimension G	2.700 in
Dimension H	1.25 in
Dimension J (Bolt Size)	0.625 in
Dimension L	3.36 in
Dimension RV	0.02 in
Dimension SV	3.14 in
C0 - Static Load	31900 lb
C - Dynamic Load (Basic)	31400 lb
e - Geometry Factor	0.23
Y1 - Geometry Factor	2.95

QVPG11V115S Bearing 2D drawings and 3D CAD models



TON BEARING CO.,LTD.

Y2 - Geometry Factor	4.40
Oil Lubrication - M/N Seal	2200 rpm
Oil Lubrication - T Seal	3800 rpm
Oil Lubrication - B/C/O Seal	1800 rpm
Grease Lubrication - M/N Seal	2200 rpm
Grease Lubrication - T Seal	3200 rpm
Grease Lubrication - B/C/O Seal	1600 rpm
Float	0.050 in
Shaft Tolerance	0.0015 in
Eng Internal Radial Clearance - Min	0.0030
Eng Internal Radial Clearance - Max	0.0037
Pre Install Clearance Min	0.0030 in
Pre Install Clearance Max	0.0037 in