

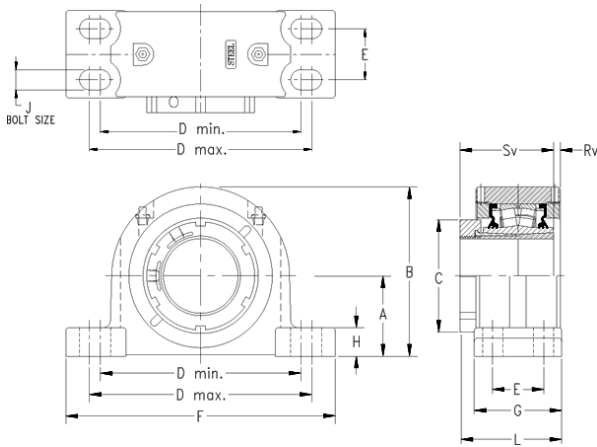

TON BEARING CO.,LTD.



timken QVPF28V130S Solid Block/Spherical Roller Bearing Housed Units-Single V-Lock Four-Bolt Pillow Block

Bearing No. QVPF28V130S

QVPF28V130S Bearing 2D drawings and 3D CAD models

Engineering Group	Mounted Bearing
Shaft Size	130 mm
Shaft Size Type	Metric
Full Timken Part Number	QVPF28V130SB
Locking Style	Single V-Lock
Weight	135 lb
Housing Style	Four-Bolt Pillow Block
UPC Code	0883450088442
Dimension A	5.50 in
Dimension B	11.01 in
Dimension C	7.48 in
Dimension D Max	15.88 in
Dimension D Min	13.75 in
Dimension E	2.75 in
Dimension F	17.50 in
Dimension G	5.040 in
Dimension H	1.54 in
Dimension J (Bolt Size)	0.875 in
Dimension L	6.03 in
Dimension RV	0.05 in
Dimension SV	5.82 in
C0 - Static Load	237000 lb
C - Dynamic Load (Basic)	194000 lb
e - Geometry Factor	0.25
Y1 - Geometry Factor	2.67



TON BEARING CO.,LTD.

Y2 - Geometry Factor	3.98
Oil Lubrication - M/N Seal	650 rpm
Oil Lubrication - T Seal	1200 rpm
Oil Lubrication - B/C/O Seal	350 rpm
Grease Lubrication - M/N Seal	650 rpm
Grease Lubrication - T Seal	900 rpm
Grease Lubrication - B/C/O Seal	350 rpm
Float	0.083 in
Shaft Tolerance	0.0050 in
Eng Internal Radial Clearance - Min	0.0063
Eng Internal Radial Clearance - Max	0.0079
Pre Install Clearance Min	0.0063 in
Pre Install Clearance Max	0.0079 in