

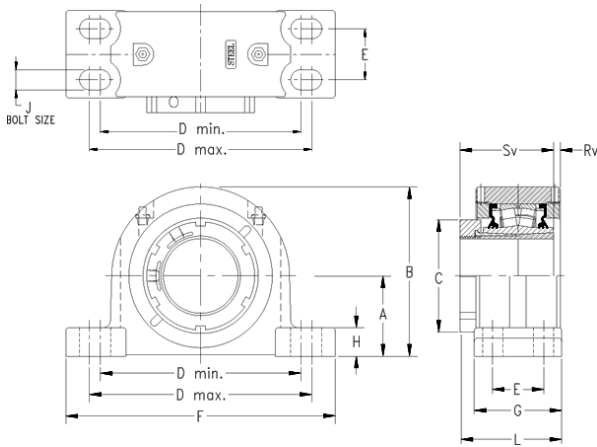

TON BEARING CO.,LTD.



timken QVPF26V115S Solid Block/Spherical Roller Bearing Housed Units-Single V-Lock Four-Bolt Pillow Block

Bearing No. QVPF26V115S

Engineering Group	Mounted Bearing
Shaft Size	115 mm
Shaft Size Type	Metric
Full Timken Part Number	QVPF26V115SB
Locking Style	Single V-Lock
Weight	83 lb
Housing Style	Four-Bolt Pillow Block
UPC Code	0883450050524
Dimension A	4.75 in
Dimension B	9.87 in
Dimension C	6.88 in
Dimension D Max	14.50 in
Dimension D Min	11.88 in
Dimension E	2.50 in
Dimension F	16.13 in
Dimension G	4.7500 in
Dimension H	1.58 in
Dimension J (Bolt Size)	0.750 in
Dimension L	5.89 in
Dimension RV	0.05 in
Dimension SV	5.82 in
C0 - Static Load	212000 lb
C - Dynamic Load (Basic)	170000 lb
e - Geometry Factor	0.26
Y1 - Geometry Factor	2.62

QVPF26V115S Bearing 2D drawings and 3D CAD models



TON BEARING CO.,LTD.

Y2 - Geometry Factor	3.90
Oil Lubrication - M/N Seal	700 rpm
Oil Lubrication - T Seal	1500 rpm
Oil Lubrication - B/C/O Seal	400 rpm
Grease Lubrication - M/N Seal	700 rpm
Grease Lubrication - T Seal	1000 rpm
Grease Lubrication - B/C/O Seal	400 rpm
Float	0.083 in
Shaft Tolerance	0.0050 in
Eng Internal Radial Clearance - Min	0.0053
Eng Internal Radial Clearance - Max	0.0067
Pre Install Clearance Min	0.0053 in
Pre Install Clearance Max	0.0067 in